

TUMBLING & MASSAGER MA3000

ABOUT DANFOTECH

Danfotech produces, installs, and services a wide range of machinery and specialized equipment for the food processing industry: bacon presses, defrosting lines, massaging tumblers, ham production lines, tenderizers, and loading/unloading systems built around cook tanks or ovens.

Additionally, Danfotech also delivers column lifts for Vemag trolleys and plastic tubs, as well as swing loaders for plastic tubs and trolleys.



+45 98 16 55 00



dftsales@danfotech.com



www.danfotech.com



Indkildevej 4M, DK-9210
Aalborg SØ, Denmark



TUMBLING & MASSAGER MA3000

Massaging is one of the most important processes in the preparation of processed meat products to optimize color and absorption of additives to produce ideal flavor and appearance. The tumbler massager has been designed to ensure efficiency, reliability, economy, and flexibility. The massage drum is intended for continuous operation with 95% vacuum.

The massager consists of a pivoting frame with a hydraulically operated massage drum. Two swivel points the frame provide a fixed pivoting connection to the frame of the unit that hold the hydraulics and vacuum pump. The design allows the massage drum to be raised or lowered even when the massager is filled.

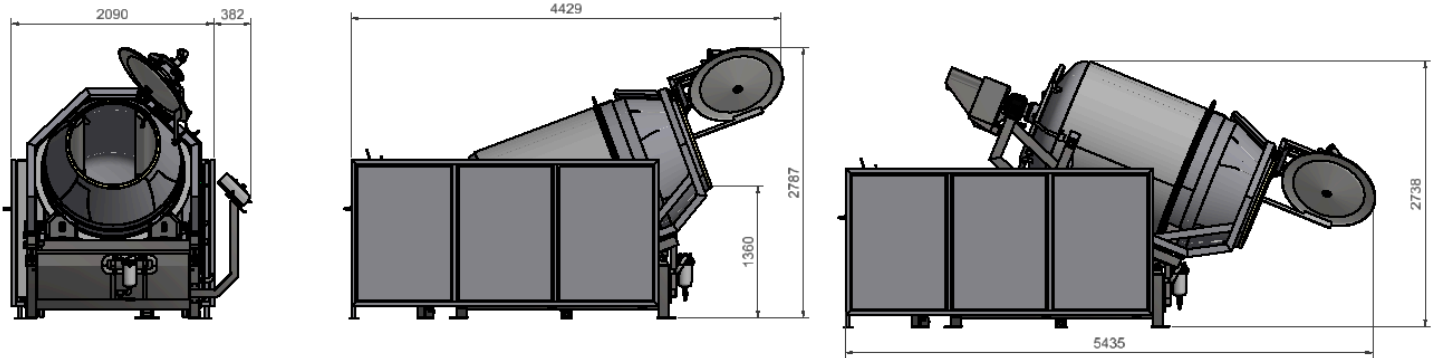

TUMBLING & MASSAGER MA3000

FOR PORK, BEEF, CHICKEN AND TURKEY

TUMBLER MASSAGER IN NUMBERS

- Models available in 1000, 3000, 6000, 8000 and 12000 Liter capacities
- Automatic vacuum filling through Ø250 mm (Ø9.8" port)
- Maximum product throughput of 8829 ft³/hour or 250 m³/hour on the largest massager model

TUMBLER MASSAGER IN BRIEF

- Designed with capability of heating and cooling product
- Optional lid design features one lid for vacuum loading and second lid for vacuum tumbling
- Hydraulic powered unit offers very slow rotation
- Ability to auto-fill both wet and dry ingredients
- Vacuum setting
- Gentle and hard massage settings
- USDA accepted and CE approved