

DEFROSTING SYSTEM MA3000

ABOUT DANFOTECH

Danfotech produces, installs, and services a wide range of machinery and specialized equipment for the food processing industry: bacon presses, defrosting lines, massaging tumblers, ham production lines, tenderizers, and loading/unloading systems built around cook tanks or ovens.

Additionally, Danfotech also delivers column lifts for Vemag trolleys and plastic tubs, as well as swing loaders for plastic tubs and trolleys.

+45 98 16 55 00

dftsales@danfotech.com

www.danfotech.com

Indkildevej 4M, DK-9210
Aalborg SØ, Denmark



DEFROSTING SYSTEM MA3000

Until now, defrosting frozen meat blocks involved exposing the product to running water, hot air, steam, or microwave tunnels. The results were far from perfect. Compared to traditional defrosting systems methods, the Danfotech Defrost system gives you an additional finished product instead of loss caused by dripping or overheating of the product.

The result is a natural-looking defrosted product attained with this revolutionary controlled heating and cooling process.

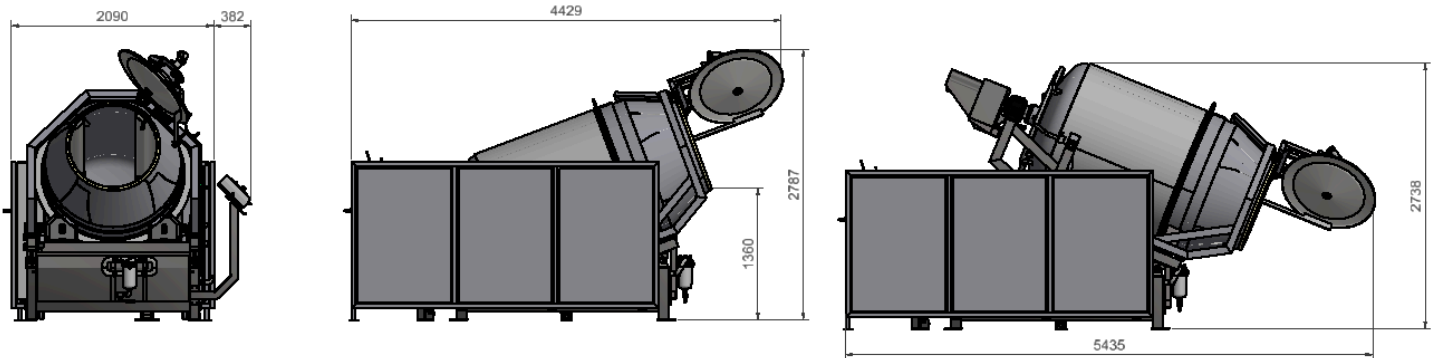

DEFROSTING SYSTEM MA3000

CLEANER AND MORE EFFICIENT WAY TO DEFROST FROZEN BLOCKS

DEFROST SYSTEM IN NUMBERS

- Models available in 3000, 6000, 8000, and 12000-liter capacities
- Defrost up to 3 batches in 24 hours, including loading, unloading, and cleaning
- Start with frozen blocks in the 0° to 10° F (-18° to -12° C) temperature range
- Tight temperature control through critical 25°-32°F (-4° to 0° C) zone
- 1% loss or less, brine returns juice to meat during massaging, no chipping or purge loss
- Variable temperature control for heating & cooling

DEFROST SYSTEM IN BRIEF

- Separate frozen meat blocks without damage to whole muscle fibers and membranes
- Process suitable for poultry, beef, pork, and fish to preserve natural qualities
- We optimized processing time without dripping or protein loss during thawing
- Thawing in the tumbler unit is controlled through indirect temperature heating through specially designed wings while the product tumbles inside
- Modular design enables separators to load multiple tumblers for larger volume utilization
- PanelView controls for a user-friendly interface